



**INSTALLATION - OPERATION - MAINTENANCE  
INSTRUCTIONS  
IN-LINE CENTRIFUGAL FANS**

**FAN EQUIPMENT CO., INC.  
2630 E. LA MADRE WAY  
NORTH LAS VEGAS, NV 89081**

**Voice: (702) 270-8344    FAX: (702) 270-8373**

**E-Mail: [info@fanequipment.com](mailto:info@fanequipment.com)**

**Visit Our Website:  
[www.fanequipment.com](http://www.fanequipment.com)**

Revised: 03/26/14



Contents

Before You Begin..... 4

Shipping and Receiving ..... 5

Off-loading & Handling ..... 5

Storage ..... 6

Foundations & Support Structures ..... 7

Installation & Start-Up ..... 11

Pre Start-Up Checklist ..... 14

Assembly & Disassembly Procedures ..... 16

Alignment of Wheel ..... 18

Bearings..... 19

V-Belt Drives..... 22

Variable Inlet Vane Dampers (V.I.V.'s)..... 23

Heat Slingers ..... 24

Shaft Seals..... 24

Preventive Maintenance and Lubrication ..... 25

Safety ..... 27

Fan Trouble Shooting ..... 29

Motor Trouble Shooting ..... 31

Maintenance Procedures..... 32

Rotor Balancing..... 32

Bearing Servicing, Cleaning, and Lubrication ..... 33

Lubrication ..... 34

Ordering Replacement Parts..... 38

Warranty ..... 40

Wheel Types..... 41

User's Notes ..... 42



Typical In-Line Fan – Arrangement 4



Typical In-Line Fan – Arrangement 9T



## Before You Begin

This manual is prepared to assist you with the installation, operation, and maintenance of your Fan Equipment Co., Inc. centrifugal type fan. The manual is generic in nature, and covers most of the concerns end users have.

Many of our assemblies are furnished with special accessories or design features. For information and instruction on custom equipment, contact your sales representative or the factory.

A dimensional drawing and performance curve are furnished as a minimum for most orders.

It is imperative that an experienced mechanic, familiar with rotating machinery, install and start-up this equipment. Factory authorized servicemen are also available to assist you with installation and start-up supervision. Fan Equipment Co., Inc. supports its equipment with the warranty policy detailed in the "Warranty" section of this manual. Please read the "Warranty" section thoroughly before adjusting or repairing any fan components. Arrangements for service work are made through your sales representative or by contacting our corporate offices in North Las Vegas, Nevada.

Engineered products are often furnished with additional data and/or information necessary for the proper operation and maintenance of your unit(s).

Please read the "Safety" section of this manual before operating your equipment.



---

## Shipping and Receiving

Unless specifically agreed otherwise, shipments are made F.O.B. shipping point. The equipment becomes the property and responsibility of the buyer at the point of shipment. All equipment is inspected and prepared for shipment in accordance with the requirements of the commercial carrier and/or any special considerations required by the nature of the product. Rough handling or the forces encountered during a long truck route may cause damage to the unit(s). The buyer should carefully inspect the shipment before accepting delivery from the carrier. Shipping damage and claims are the responsibility of the buyer for shipments made F.O.B. shipping point.

All damage or shortages discovered at time of delivery must be noted on the carrier's freight bill or bill of lading. Any damage or shortages discovered after delivery must be reported to the carrier immediately. The carrier should inspect the damage with you and a concealed damage report filed.

Most centrifugal fans are shipped completely assembled and mounted on wooden pallets or skids, suitable for fork lift off loading and handling. Larger equipment is furnished with lifting lugs for off-loading and handling.

Large accessories such as inlet boxes, damper assemblies, and sound attenuators may be shipped separately because of handling and shipping size restrictions. Sensitive accessories such as damper actuators or other instrumentation devices are shipped separately to avoid damage in transit.

## Off-loading & Handling

Most shipments can be off loaded and handled by standard fork lift trucks. Lifting lugs are generally provided for attachment of lifting hooks. If necessary, lift the equipment with ropes or slings placed under structural support members or the circumference of the in-line housing. Large fans that require crane equipment for handling must be lifted with a spreader bar fixture provided by others. Slings must be provided so that damage to the equipment is avoided; particularly special protective coatings provided for corrosion protection during operation. All scratches must be touched up after final installation and



handling.

Fan rotors are always factory balanced before shipment. Differences in mounting shafts and foundation support structures may require a field "touch up" balance after final installation. Acceptable residual rotor unbalance levels are scheduled in other sections of this manual. When handling fan rotors; DO NOT lift by attachment to blades or shroud (flange); roll wheels; or place excessive loads on shaft. The motor eye bolt is for lifting the motor only.

## Storage

It is best for equipment to be installed and operated upon receipt. As this is not always possible, the equipment should be stored in a dry, protected area. The fan shaft should be protected with oil base coatings; the bearings must be kept clean, dry, and lubricated; and the fan rotor must be kept clean, dry, and free from corrosive or erosive elements. The fan rotor should be rotated frequently to circulate lubricants in the fan bearings and to prevent brinnelling of the bearings. Do not store equipment with vibration isolators installed. Never store other materials by stacking or piling items on the fan. Whether stored indoors or outdoors, always protect the equipment with tarps, and protect electrical equipment from corrosion.

### Long Term Storage

If the fan is to be stored for over thirty (30) days, the following procedures are to be followed:

1. Add additional grease to bearings to fill voids and prevent condensation from accumulating.
2. Cover and seal bearings to prevent contamination.
3. Remove drive V-belts and store in a dry, protected area. Belts should be stored in plastic wrap.
4. Coat the fan shaft with grease or other protective coating.
5. Coat drive sheaves with rust preventative, and cover with plastic wrap.
6. Seal the inlet and outlet openings with heavy plywood.
7. Cover the motor with plastic wrap.
8. Cover the entire fan with protective tarps or waterproof paper.



## Periodic Attention

1. Rotate the fan shaft every thirty (30) days to circulate the grease in the bearings.
2. Purge the bearings of grease and condensation every sixty (60) days.  
Rotate the shaft while purging grease. Do not use high pressure pneumatic greasers.
3. Renew the protective coatings on the shaft, sheaves and motor every ninety (90) days.
4. If extended factory warranty provisions are part of your purchase order, a complete log of the storage maintenance procedures is required. As a minimum you must record: the day of inspection, name of service personnel, findings and comments for each maintenance item performed.

## Preparation for Start-Up

1. Prior to start-up, purge and clean the bearings, re-lubricate per the applicable bearing section that follows.
2. Remove any rust from the drive components, and inspect the drive belts for condition.
3. Manually rotate the fan impeller and check for proper running clearances.
4. Check all bearing and drive set screws, hold down bolts and motor mounting bolts for tightness.
5. Prior to installation of drive V-belts, run the motor for ten (10) minutes and confirm proper current draw and mechanical operation.

## Foundations & Support Structures

The foundation and/or support structure you provide for this equipment is essential for proper fan operation. A well designed foundation must be flat, level, and sufficiently rigid to assure that the natural vibration frequency of the foundation is stable and adequately separated from the rotational natural vibration frequency of the fan. This consideration must be closely studied when fans are mounted above grade, on structural steel support members. Incorrectly designed foundations or support structures can cause excessive equipment vibration levels and seriously endanger personnel.



The following considerations are offered as an introduction only to the fundamentals of foundation design. The fan manufacturer cannot be responsible for foundation designs. Qualified engineers familiar with local soil conditions and building codes must prepare the foundation design details.

## Concrete Slab Foundations

A heavy, poured concrete slab, on grade, is the best foundation design. The concrete should weigh at least 3 to 5 times the combined weight of the fan and drive component accessories. The footing should be large enough to prevent settling. The top of the slab should extend beyond the outside boundaries of the equipment by 6 to 8 inches. The slab should be poured in one piece; then bevel the edges to prevent chipping and for drainage.

The best anchor bolts are "L" or "T" shaped, and should be set in pipe sleeves approximately 2 inches larger than the anchor bolt diameter. The sleeves provide some tolerance when aligning the anchor bolts with the fan base angle foundation holes. Anchor bolt length must consider the thickness of leveling shims, the fan base angle thickness, the thickness of washers and nuts, plus allowing extra bare threads for adjustment. The thread area of the bolts must be clean and lubricated. The gap between the fan base angle and the foundation slab must be filled with grout after the fan is positioned and leveled. Gaps between the foundation slab and the fan base angle can contribute to excessive vibration.

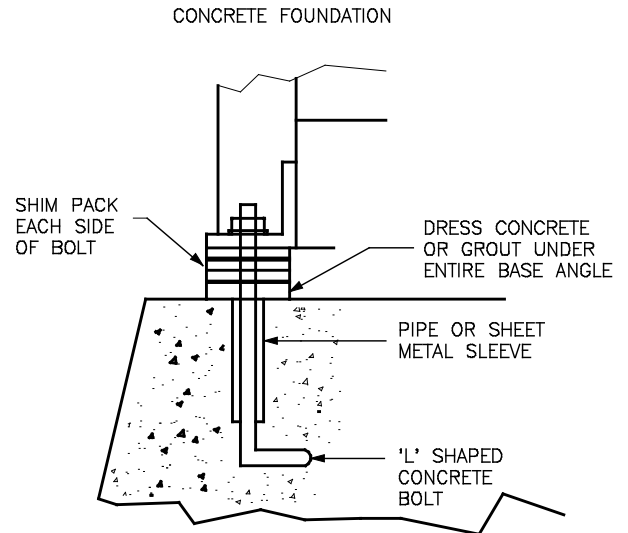

## Structural Steel Support Foundations

Fans that must be mounted above grade, on structural steel support structures, require special attention at design. The structure must be designed to support the equipment weight plus all dynamic loads of operation. Natural frequencies for fabricated structures are sometimes excited by the equipment's rotating frequencies. Support members should be as heavy as possible, and include concrete reinforcements.

**The use of spring isolators for equipment mounted on structural steel work is strongly discouraged.** The use of springs adds another complication to the already difficult task of designing an adequate structural steel support structure.



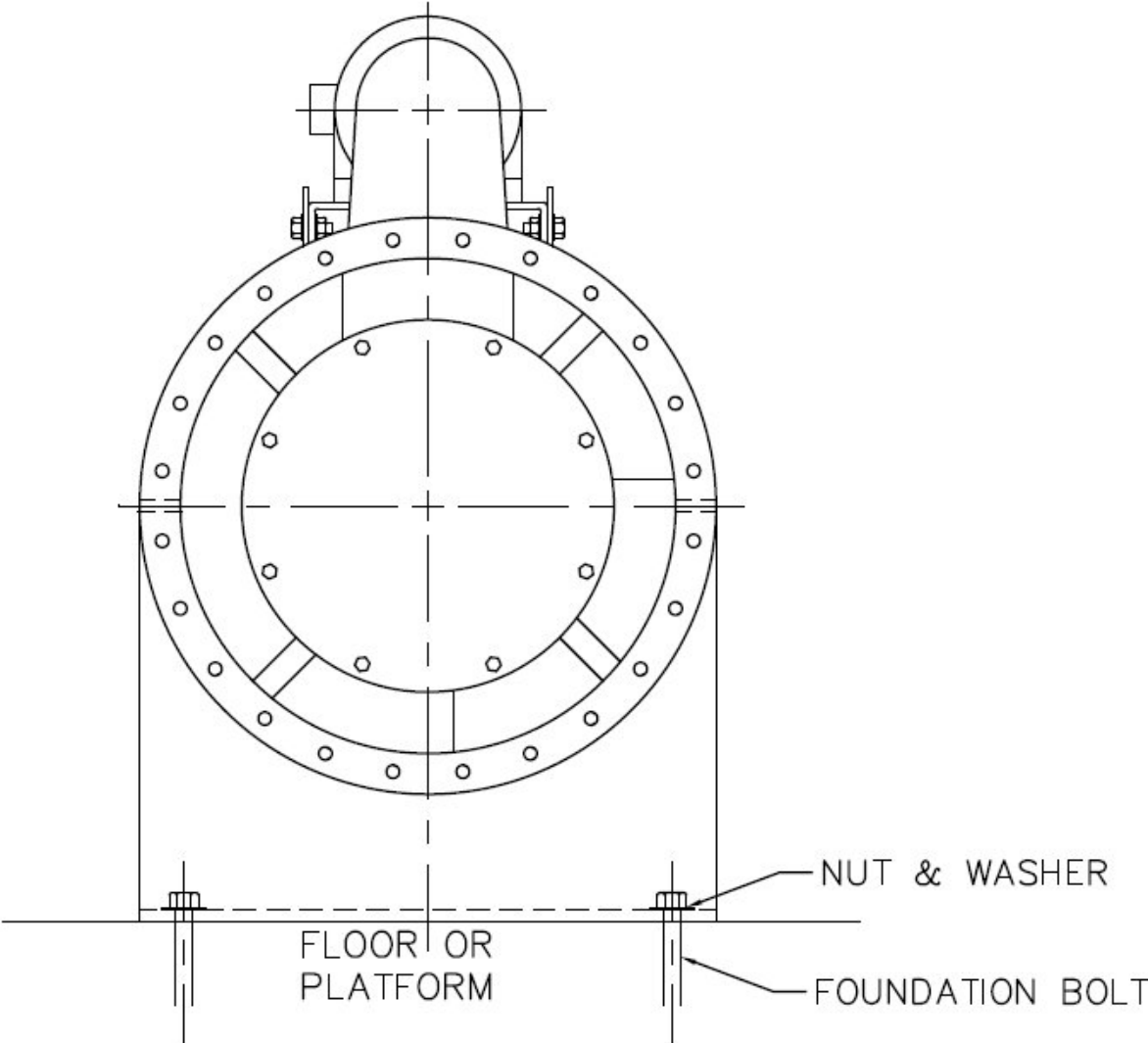

### Equipment Mounted Fans

Fans that are mounted as auxiliary equipment on other machines, or on mobile trailers, must be mounted so that vibration is prevented from being transmitted between the units. In certain instances, vibration isolators may be helpful.



## Suspended Fans

For suspended units, properly selected vibration hangers must be provided. Units installed in the duct work must be provided with suspension clips and hanging rods selected with sufficient load bearing capacity to support the fan unit.

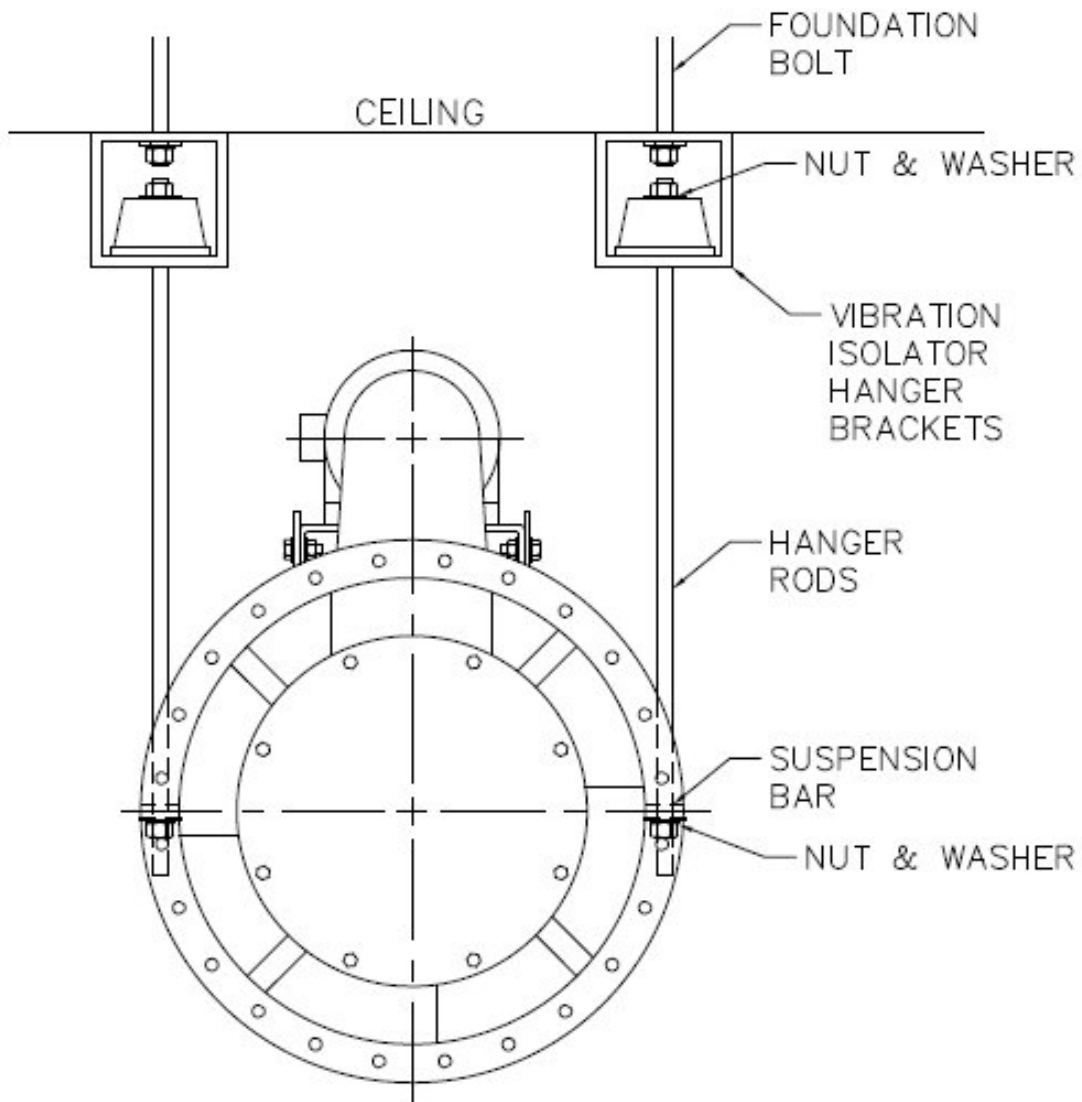



---

## Installation & Start-Up

### General Comments

It is Fan Equipment Co., Inc.'s standard procedure to test run and balance signature all complete fan units up to and including 500 HP. Your fan will be correctly aligned, lubricated, and shipped assembled; ready for mounting on a properly designed foundation. The forces encountered during shipment, handling, and rigging can however, disturb the factory settings. Before operating the fan, be sure the following items and the Start-Up Procedure outlined later in this manual are satisfied. Fans can be mounted either horizontally or vertically. Vertically mounted fans, however, require special considerations. Contact Fan Equipment Co., Inc. if your fan must be changed from horizontal to vertical mounting. When installing fans, be sure to allow adequate space for inspection, maintenance and lubrication. Provide access doors for duct mounted units.

### Anchoring to Foundation

Position the fan such that the mounting holes in the fan base angle are in line with the anchor bolts set in the foundation. If vibration isolators are used, position the isolator's mounting holes over the foundation anchor bolts. Lower the fan onto the anchor bolts. Level the unit, and align the duct connections with the fan collars or flanges. The fan flanges are not designed to support duct loading or moment forces. All ducting into and from the fan must be independently supported. Duct connections that are misaligned will impart loads to the fan that can distort and alter critical fan tolerances that can adversely affect performance or mechanical behavior. Grout in the gap underneath the fan base angle and securely tighten all anchor bolts.

### Ceiling Suspended Units

Raise the fan into its' proper position under the hanger rods (not supplied by Fan Equipment Co., Inc.). Insert rods through suspension clips and attach washers and fastening nuts. Level the unit and align flange mounting holes by adjusting the hanger rod length.

### Duct Work Supported Units

Raise the fan to its' proper position and bolt through the fan flanges to the companion flanges of the duct work.



## Bearings

Bearings on factory assembled units will have been properly lubricated, and are ready for operation. Bearings shipped loose, as replacements or spares, will require cleaning and lubrication prior to operation.

## V-Belt Drives

V-belt drives on factory assembled fans have been properly aligned and tensioned. The alignment must, however, be checked and corrected prior to operation. This must be done to correct any movement that occurred during shipping and handling. A sufficiently long straight edge or length of string is the best reference for checking the sheave alignment.

### To mount V-belt drives:

1. Clean the motor and fan drive shafts, removing any protective coatings. Remove any burrs or rough spots; and coat the shafts with a light lubricant.
2. Mount the fan and motor sheaves to their respective shafts. Hand pressure only is required. ***Do not pound on the sheaves with hammers to install or remove.***
3. Clean the sheave grooves of all oil, rust, grease, and metal burrs.
4. Loosen the motor base adjusting screws so that the drive belts seat in the grooves without forcing. ***Do not roll the belts or use a tool to move the belts over the grooves.***
5. Align the fan and motor shafts parallel to each other; and at right angles to the belts. Use a straight edge or length of string pulled taut over the faces of the sheaves to sight alignment.
6. Tighten the belts by adjusting the motor base adjusting screws. Proper belt tension is measured with a belt tension gauge. Excessive tension can damage the fan and/or motor bearings.

For adjustable pitch sheaves, belts are tensioned by moving the motor on its' mounts or base; not by changing the pitch diameter of sheave grooves.



## Drive Motor Wiring

Wiring of all electrical accessories must be in accordance with the motor manufacturer's recommendations and wiring diagrams. Electric motors have connection diagrams on the nameplate. Fan motors must be connected to the power supply through a delegated disconnect switch and magnetic starter, with suitable over-load and short circuit protection. All wiring must comply with the National Electrical Code (NEC) and local code requirements.

**ALL MOTOR DRIVEN FANS MUST BE CONNECTED TO A DISCONNECT SWITCH SO THAT THE MOTOR CAN BE POSITIVELY ISOLATED FROM THE POWER SOURCE. MAINTENANCE PERSONNEL MUST CONTROL POWER TO THE UNIT TO AVOID ACCIDENTAL STARTING OF EQUIPMENT DURING MAINTENANCE OR REPAIR**

Motor conduit boxes can be rotated in 90° increments to connect to the power source. Be sure the power source voltage and amperage is compatible with the motor requirements and that the insulation class is compatible with the ambient temperature. Electric motors are designed to run at temperatures up to 180° F. The total motor operating temperature is a combination of the ambient temperature and the motor temperature rise caused by resistance of the electrical windings.

Motors are generally provided with the bearings factory lubricated and ready for operation. It is the owner's responsibility however, to confirm that the motor bearings are lubricated before start-up.



---

## Pre Start-Up Checklist

**Before initial start-up or after servicing, perform the following checklist:**

1. **CONFIRM ALL FASTENERS ARE SECURE.** All foundation anchor bolts, bearing hold down bolts, locking collars, wheel retaining set screws, bearing set screws, and sheave mounting bolts must be properly tightened.
2. Check V-belt drive alignment and belt tension.
3. Check bearing alignment and lubrication.
4. Rotate the fan wheel by hand to check that it turns freely, and does not strike the housing or inlet cone. **DO NOT START THE FAN IF ANY METAL TO METAL RUBBING SOUNDS ARE DETECTED.**
5. Confirm all electrical connections are as described in the previous section and in compliance with all applicable codes and standards.

6. Make sure all access door and bolted covers are sealed and tight. Doors, covers and inlet cones are held by nuts threaded onto weld studs. The maximum torque allowed for these fasteners is shown on the chart to the right.

Stud Size	Torque (Ft-Lbs)
1/4"	4
5/16"	8
3/8"	12
1/2"	30
5/8"	60

7. Variable inlet vanes or dampers (if supplied) must move freely.
8. Duct connections must not impose loads on the fan. Expansion joints should be used when movement is expected from thermal growth or if the fan is mounted on vibration isolators. All ducts and connections must be sealed air tight. All connections must be installed so that air flow, into and out of the fan, is not obstructed.

### **Caution**

Never torque bolts in series (i.e. start tightening at 12:00, 1:00, 2:00, 3:00, etc.).

Always use a staggered torquing sequence. Start tightening at 12:00 then 6:00 then 3:00 then 9:00, etc.



---

## Start-Up Procedure

After satisfying the considerations listed in the previous section, read all special instructions that apply and follow this procedure:

1. "Bump" the motor to determine proper direction of fan wheel rotation. Arrows on the fan or motor show correct rotation. If rotation must be changed, reverse any two (2) motor leads on three (3) phase motors. For single phase motors, refer to the motor wiring diagram.
2. Energize the starter circuit and allow the fan to accelerate to full speed. Generally motors are sized so that operating fan speed is obtained in fifteen (15) seconds. Large diameter fans and narrow width high pressure blowers may take twenty (20) or more seconds to achieve rated speed. ***IT IS THE OWNER'S RESPONSIBILITY TO FURNISH ELECTRICAL COMPONENTS CONSISTENT WITH THE DRIVE MOTOR'S LOCKED ROTOR STARTING CHARACTERISTICS.***
3. The drive V-belts will "chirp" or "squeal" briefly at start-up. Higher horsepower fan drives may actually generate a small amount of smoke as the drive V-belts are suddenly activated at start-up.
4. Observe the fan and motor as the fan runs at operating speed. Unusual vibration or overheating of the bearings should be investigated immediately. It is typical for anti-friction bearings to exhibit a running surface temperature in excess of 165° F. This surface will be too hot to touch, but is not cause for alarm. Refer to the engineering data supplied for your fan unit, or consult the factory for specific information regarding bearing temperatures.
5. Check the fan after it has run for approximately eight (8) hours. Stop the fan and recheck all alignments, inspect the bearings, re-tighten all hold down bolts, re-tension drive V-belts, and tighten all set screws.
6. In-Line fans must not be operated in the *stall* or *surge* region of their performance curve. The *stall/surge* region of the performance curve is any region in which the system resistance line does not pass through the traditional downward sloping portion of the curve. Operation in the *stall/surge* region may result in severe damage to the fan equipment and/or personnel.



---

## Assembly & Disassembly Procedures

These procedures apply to all fans.

Specific instructions for special drive arrangements are noted by **bold** type.

### Disassembly

**MAKE CERTAIN THE ELECTRIC POWER IS TURNED OFF AND WILL REMAIN OFF BEFORE BEGINNING.**

1. For units without mounting legs provide floor blocks to prevent rolling.
2. Remove accessories as necessary, and remove the fan from the duct work system.
3. Working from the air entering side of the fan, unbolt the inlet cone and remove from the fan.
4. Remove the bolts securing the taper-lock bushing into the wheel's hub. Insert these same bolts into the previously unused holes in the taper-lock bushing and tighten slowly and evenly, alternating torques between each bolt. This action will press the taper-lock bushing out of the wheel's hub. Remove the taper-lock bushing. Remove shaft key. Larger size fans will have straight bore hubs which are fastened to the shaft by two (2) set screws. Remove these set screws and drift out the key.
5. Carefully slide the wheel off the shaft.
6. Remove belt guard.
7. Working from the air leaving side of the fan - unbolt the inner cylinder cover plate and remove from the fan.
8. Remove the fan sheave by withdrawing the taper-lock bushing as described above.
9. Remove the hub set screws fastening the aspirating wheel (if furnished for hi-temperature applications) to the fan shaft and remove the wheel from the fan.
10. Unbolt the aspirating wheel's inlet cone and remove from the fan.
11. The fan bearings can now be removed and serviced as detailed on the following pages.
12. The compressed carbon fiber shaft seal is removed by unbolting and removing the retaining plate. Slide the shaft seal off the fan shaft.
13. To remove the motor, remove the bolts holding the motor to the motor base.





## Reassembly

To reassemble, reverse the sequence of operations itemized above. Properly prepare the fan bearings for remounting (as described on the following pages), and perform these additional procedures:

1. De-burr fan wheel's hub, apply a light lubricant, and slide the wheel onto the shaft.
2. Apply silicone or other seal/gasket substance compatible with the gas stream to the fan mating surfaces,
3. Refit the inlet cone.
4. Adjust the wheel position to provide for proper inlet cone overlap. Fan wheels fastened with taper-lock bushings require the wheel to be positioned slightly back from the inlet, as the wheel will move forward when the bushing is tightened.
5. Secure the fan to a rigid, level foundation as previously discussed.
6. Align V-belt drive components; tighten down motor hold down bolts.
7. Replace all accessory items.
8. Perform Prestart-up check as described earlier.



---

## Alignment of Wheel

Align the wheel to the housing or inlet cone(s) by following this procedure:

1. Level the fan on its foundation as described previously. Tighten the anchor bolt nuts.
2. If mounted on a concrete foundation pour the grout, let harden, and check for final alignment and leveling.
3. Check that motor and bearing hold down bolts are tight.
4. Check v-belt drive alignment.
5. Rotate wheel by hand; check that the wheel runs freely without rubbing at any point. There will be an overlap of the fan wheel shroud and inlet plate or cone(s) on almost all fans. Check that this clearance is set as listed below.
6. The wheel must be positioned at an offset on high temperature fans. The wheel should be set to allow for thermal growth of the fan shaft, wheel, inlet fixture, and housing as listed below.

### Arrangements No. 1, 4, 7, 8, & 9 for Single Width, Single Inlet

<u>Temperature Range</u>	<u>Wheel/Inlet Fixture Gap</u>
Up to 200° F.....	Evenly Spaced
201° to 350° F.....	1/16" Gap - all sizes
351° to 700° F.....	1/8" Gap - all sizes
701° to 800° F.....	3/16" Gap - all sizes



---

## Bearings

Fan wheels and shafts for fans furnished in arrangement No. 9 are supported primarily by pillow block anti-friction bearings. Fan Equipment Co., Inc. uses a variety of roller, ball or sleeve type bearings depending on the application and service conditions of the fan. Generally the following procedures should be followed when disassembling and reassembling all pillow block bearings:

1. Determine the size and type of the subject bearing.
2. Note the position of the fixed and expansion bearings. Replacement in the exact location is essential for proper bearing temperature, performance, and service life.
3. Refer to your specific submittal data for any special considerations or procedures applicable to your fan unit.
4. Match mark all parts to avoid reassembly errors; do not mix and interchange parts from one bearing to another. Inspect and clean all parts with mineral spirits.
5. Clean and de-burr the fan shaft. Polish out all small irregularities with emery cloth. The bearing must not be seated on worn or flat sections of the shaft. Fan shafts that are worn and/or damaged must be replaced.

***Slide bearings into position on the fan shaft, and follow the steps below for each type of bearing:***

### **Flange Cartridge; 200 and 300 Series Pillow Block Bearings**

Installation is as follows:

1. Slide the bearing with extended inner race into position on the fan shaft.
2. Tighten the bearing hold down bolts finger tight.
3. Align the rotating assembly so the wheel does not strike any part of the housing or inlet fixture.
4. Securely tighten the bearings to the bearing support stand.
5. Tighten the self-locking, cupped point screws or spring locking collar onto the fan shaft.
6. Reattach any extended grease lines and fittings.
7. Fill the grease lines and bearing housings with grease; **taking great care not to over fill the bearing pillow block with grease. A bearing with too much grease in it will overheat and fail prematurely.**



---

## **Link-Belt P-LB 6800, Dodge USAF 500, and SKF SAF 225 Series Split Pillow Block Roller Bearings**

These bearings are either fixed or floating (expansion), split pillow block, spherical roller-bearing assemblies. Installation is as follows:

1. Set the bottom section of the split housing in place on the bearing support pedestal.
2. Apply anti-seize compound to outside diameter and threads of tapered sleeve and face of lock nut to aid in tightening of the adapter.
3. Position the multi-labyrinth seal ring (if used), adapter sleeve, roller bearing element, lock washer, lock nut and second seal loosely; slide onto the fan shaft.
4. Securely hand tighten the lock nut onto the adapter sleeve.
5. Insert feeler gauges between the outer ring and the unloaded roller bearing, on both sides of the bearing, until a snug fit is obtained. Record this gauge measurement.
6. Lower the fan shaft with the bearing and adapter assemblies into the bottom section of the pillow block housing. Take care to align the labyrinth seals with the seal grooves in the housing pillow block.
7. Loosely bolt the bottom pillow block sections to the bearing support pedestal; align the assembly with shims so that the wheel does not strike the housing or inlet fixture. Shims are also placed under the bearings to "center relieve" the hold down tension.
8. Position the floating (expansion) bearing insert centrally in the bottom pillow block housing section.
9. The fixed bearing insert is positioned for placement of a spacer ring that fits on the lock nut side to keep the bearing flush with the opposite side of the pillow block housing.
10. Snug-up the lock nut with a wrench.
11. Place a brass drift against the lock nut and strike the drift repeatedly. Evenly distribute the blows by rotating the fan shaft between strikes. This procedure drives the inner ring farther up on the adapter sleeve and releases pressure on the threads. Use the wrench again to tighten the lock nut. Repeat this procedure until the clearance has been reduced to the desired amount as shown in the table below. Record this value.
12. Secure the lock nut by bending the lock washer tang into the lock nut slot.
13. Insert the spacer into the fixed bearing housing on the lock nut side.
14. Lubricate the bearing with grease or oil.
15. Check that the bearing races are not cocked in the housing; apply a sealant such



as “permatex” on the housing mating surfaces; and mount the top half of the pillow block housing to the bottom half.

16. If the bearing seals are free to rotate with the shaft and stop easily; tighten the hold down cap bolts.

## Bearing Clearance Reduction for Spherical Roller Bearings

<u>Size</u>	<u>Dodge Min</u>	<u>Link-Belt Min</u>	<u>SKF Min</u>	<u>Dodge Max</u>	<u>Link-Belt Max</u>	<u>SKF Max</u>
1 7/16	0.0010	0.0010	0.0010	0.0012	0.0012	0.0012
1 11/16	0.0010	0.0010	0.0010	0.0012	0.0012	0.0012
1 15/16	0.0012	0.0012	0.0012	0.0015	0.0016	0.0015
2 3/16	0.0012	0.0012	0.0012	0.0015	0.0016	0.0015
2 7/16	0.0015	0.0016	0.0015	0.0020	0.0020	0.0020
2 11/16	0.0015	0.0016	0.0015	0.0020	0.0020	0.0020
2 15/16	0.0018	0.0018	0.0018	0.0025	0.0024	0.0025
3 3/16	0.0018	0.0018	0.0018	0.0025	0.0024	0.0025
3 7/16	0.0018	0.0018	0.0018	0.0025	0.0024	0.0025
3 15/16	0.0020	0.0020	0.0020	0.0026	0.0028	0.0028
4 3/16	0.0020	0.0020	0.0020	0.0026	0.0028	0.0028
4 7/16	0.0025	0.0026	0.0025	0.0035	0.0035	0.0035
4 15/16	0.0025	0.0026	0.0025	0.0035	0.0035	0.0035
5 3/16	0.0030	0.0030	0.0030	0.0040	0.0039	0.0040
5 7/16	0.0030	0.0030	0.0030	0.0040	0.0039	0.0040
5 15/16	0.0030	0.0031	0.0030	0.0045	0.0043	0.0045
6 7/16	0.0030	0.0031	0.0030	0.0045	0.0043	0.0045
6 15/16	0.0035	0.0035	0.0035	0.0050	0.0051	0.0050

All dimensions in inches.

***When replacing bearing inserts on assembled fans, it is MANDATORY that measurements and adjustments be made with ONLY the weight of the fan shaft supported by the bearings. ALL loads imposed by the fan rotor and other accessories, such as drive sheaves must be supported by blocks or other means.***



---

## V-Belt Drives

V-belt driven fans that are factory assembled have been aligned and test run before shipping. Because of the forces encountered during shipping and handling the drive alignment must be checked before operation as follows:

1. Check that sheaves are locked in position with keys firmly installed and seated.
2. The sheave faces must be parallel as checked with a straight edge or string.
3. Start the fan and check for proper rotation.
4. Run the fan at operating speed. A slight bow should appear on the slack side of the belts.
5. Adjust belt tension, if required, with a belt tension gauge by adjusting the position of the motor on its' sliding base.
6. The drive belts will squeal a bit, especially higher horsepower units, upon start up.  
**DO NOT OVER-TIGHTEN THE BELTS.**
7. Please refer to the manufacturer's detailed instructions.

## To assemble or replace V-belt drives

1. Clean the motor and fan shafts. Be sure they are free from corrosion. Clean the bore of each sheave and coat with white grease or oil. Then remove all oil, grease, rust and burrs from the sheaves.
2. Place the fan and motor sheaves on their respective shafts. **DO NOT POUND THE SHEAVES ONTO THE SHAFTS**, as this might damage the bearings. Tighten the sheaves in place. The sheave should be as near as possible to the bearing pedestal without the sheave or belts hitting the support pedestal.
3. Move the motor on its slide base until the belts can be placed in the sheave grooves without forcing. Do not roll belts or use a tool to force the belts over the grooves.
4. Adjust the fan and motor sheaves so they are parallel. Use a straight edge or string pulled taut against the sheave faces to check for squareness. The belts should be at right angles to the shafts.
5. Tighten the belts by adjusting the motor slide rail screws, moving the motor back on its' base. Use a belt tension gauge to determine proper belt tension. Excessive tension can cause premature bearing and/or belt failure.



6. Start the fan and run at full speed.
7. Continue the process of adjusting belt tension until a slight bow appears on the slack side of the belts. Give the belts a few days running time, then readjust the belt tension.

**NOTE:** High temperature fans will require frequent belt tension adjustments. Although the inner cylinder is aspirated with cooler ambient air, the drive V-belts will be exposed to higher than normal temperatures. This causes the belts to continually stretch requiring regular maintenance.

## Variable Inlet Vane Dampers (V.I.V.'s)

Variable inlet vane dampers are used to control the fan's capacity through moveable vanes located at the fan inlet. The vanes are joined together by a linkage assembly so that the vanes move in unison when operating the control shaft. Most V.I.V. assemblies are furnished as separate bolt-on sections. Some fans, however, are furnished with the vanes "nested" inside the fan inlet cone throat. Double width fans are furnished with two (2) separate V.I.V. assemblies, connected to a common linkage so that both vane assemblies move in unison with one (1) control shaft.

The V.I.V. section is assembled and adjusted for proper operation at the factory before shipment. When the fan is received at the job site; check that the vanes spin the air in the same direction as the wheel rotates. Before the inlet duct work is attached, operate the control lever to make certain the vanes move freely from fully open to fully closed.

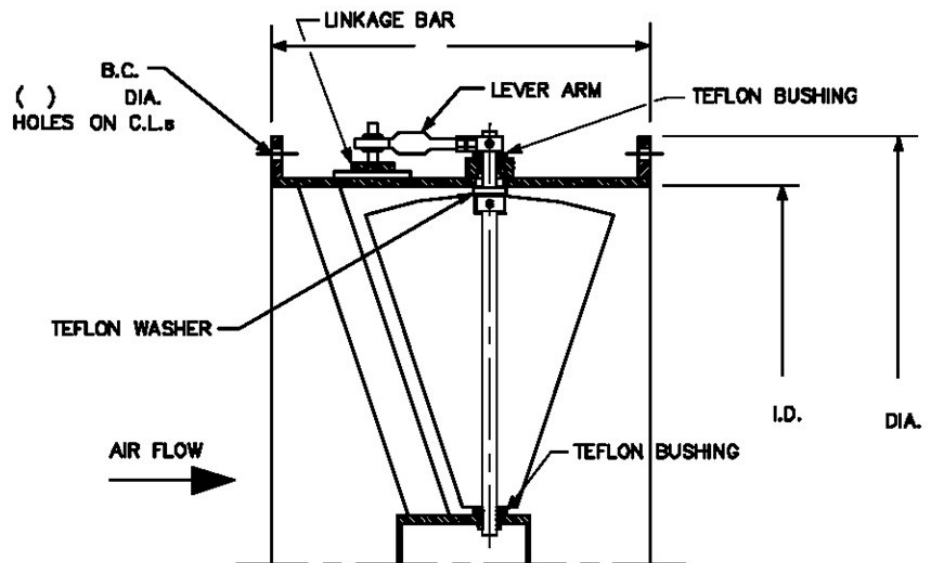



V.I.V.'s provided for manual operation are furnished with a locking quadrant and wing nut to fix the control lever after system adjustments are made.

V.I.V.'s may also be furnished with automatic actuators which follow a system control signal to balance air flow performance. Automatic actuators come in all sizes and shapes. The mounting bracket is the responsibility of those supplying and mounting the actuator. When called for, Fan Equipment Co., Inc. furnishes and factory mounts the automatic actuator assemblies.

## Heat Slingers

A heat slinger is a split aluminum rotor bolted to high temperature fan shafts to dissipate heat conducted along the fan shaft; and to induce air flow around bearing housings. Heat slingers are installed by placing the two (2) halves over the fan shaft and bolting together as follows:

- The open side of the heat slinger should face the fan when the fan has oil lubricated bearings.
- The open side of the heat slinger should face the bearings when the fan is furnished with grease lubricated bearings.
- The open side of the heat slinger should face the motor on arrangement No. 4 fans.

## Shaft Seals

**Simple rubbing shaft seals** are provided for most fan applications. These seals are cut from rigid sheets of compressed carbon fiber or Teflon . The seals are welded to the fan shaft with weld studs and a retaining plate. Air leakage along the fan shaft is minimal, but definitely present.





---

## Preventive Maintenance and Lubrication

### Maintenance

To insure trouble free operation and long life, a regular schedule of preventive maintenance and lubrication must be followed. Frequency of inspection and lubrication depend upon the operating conditions and the time period the fan is used. We recommend daily observation after the fan is first put into service, to determine the inspection and lubrication requirements.

**Do not make any repairs or alterations to the fan equipment during the warranty period without Fan Equipment Co., Inc.'s prior authorization or the warranty is void.**

### **CAUTION! :**

- **Before performing any inspection, make sure that the fan is locked OFF so that the unit cannot be started.**
- **Do not shut down fans handling high temperature gas or air until the system cools down.**

Periodic inspections should include the following items:

1. **Air Flow** - Check for obstructions, dirt rags, etc. in the inlet or outlet duct work.
2. **Screens, V.I.V.'s, and other flow accessories** - Clear periodically, dirt causes resistance to air flow, decreasing the air volume supplied by the fan.
3. **V-belt Drives** - Check for belt wear, alignment of sheaves, and belt tension. Replace belts in matched sets only. New belts will not perform properly when used with used belts because of length differences. Belts must be free from grease and oils.
4. **Wheel** - Inspect the blades for dust or dirt accumulation. Particulate build up can cause unbalance. Cover the bearings with plastic film and clean with steam, water jet, compressed air, or wire brush. If blades are aluminum, be careful not to damage them while cleaning. Make sure wheel is centered to prevent blades from striking the housing. Check for proper wheel rotation. **If cracks** are found in the wheel, remove the fan from service until proper repairs can be made.
5. **Hardware** - Check that all foundation bolts, wheel hubs, set screws, wheel locking fixtures and bearing hold down bolts are sufficiently tight.



6. **Shaft** - Check that all shafts are properly aligned. The shaft must not be cocked in the bearings because misalignment causes overheating, wear to dust seals, bearing failure, and rotor unbalance.
7. **Bearings** - Check for excessive temperature or chatter in all bearings. High speed bearings are designed to run at temperatures above 165° F. **Do not replace a bearing simply because it feels hot.** Check the pillow block temperature with an accurate surface contact thermometer and contact Fan Equipment Co., Inc. for assistance.
8. **Surface Coatings** - Check that surface coatings or paints are in good condition. Repainting of exterior and interior surfaces extends the service life of your equipment. Select coatings to withstand the operating temperature and chemical content of the gas stream. For normal temperature and service conditions, a good machinery enamel may be used.
9. **Alignment** - Check the alignment of fan bearings, flexible couplings, wheel, and inlet cones regularly. Misalignment causes bearing and/or motor overheating, wear to dust seals, bearing failure, and rotor unbalance.
10. **V.I.V.'s** - The linkage connections must be checked for tightness. Check all automatic dampers for freedom of movement. Blades should close tightly and evenly. Clean damper blades and linkages and inspect for corrosion and erosion. Observe as operating motors and controls stroke through a complete cycle - make adjustments or repairs as necessary.
11. **Motors** – Keep open motor windings clean by removing dust and dirt because contamination causes excessive insulation temperatures. **Keep motors dry.** When motors are idle for long periods of time, single phase heating or small space heaters may be necessary to prevent water condensation on the windings. **Be sure the motor is not overloaded. Excessive starting of motors may burn out the motor. Check the amperage draw against the motor nameplate rating; and consult the manufacturer for the maximum allowable number of consecutive starts.**



---

## Safety

Improperly installed or operated fans are a hazard to both people and property. Fans should always be installed by trained and experienced personnel. Installations must meet all pertinent state and local safety codes and the requirements of the Occupational Safety and Health Act (OSHA).

Each fan is designed to operate safely up to a stated maximum speed (RPM) and Temperature. ***DO NOT EXCEED THESE LIMITS.***

**Fans are specialized equipment which involve high speed rotating elements which can be dangerous if handled improperly. Individuals who are not familiar with the equipment and proper servicing methods may not realize the harm they can do to themselves or the fan; and should NEVER be permitted to work on the fan. Fans are sold with the understanding that customers will recognize the risk of high speed rotating elements and understand that only people who are aware of the risks associated with the essential operating characteristics of a fan should be permitted to work on them.**

### Safety Checklist:

The following points must be included in your Safety Checklist Program:

1. Flexible couplings and V-belt drives must have guards that completely encase the rotating parts. Do not start or operate the equipment without guards.
2. Shaft guards should be provided for Arrangement No. 1, 8, and 9 fans. Guards should extend from one bearing to the other.
3. Screens should be provided for open inlet fans, and for outlets not connected to duct work.
4. Accessories with moving parts such as tachometers, turning gears, and heat slingers must have guards.
5. Before start-up be sure all parts are tight; that all tools and materials have been removed from the area, and that all personnel are clear.
6. The periodic maintenance and lubrication procedures outlined in this manual must be faithfully followed.
7. A lock out procedure to ensure that the fans cannot start when maintenance personnel are performing service functions is mandatory. It is customary to lock out the power from the drive and use red tags to alert personnel to the shut-down.



Only well trained personnel should assemble, maintain, or replace these fans.

- NEVER allow an untrained person to work on the fan.
- NEVER remove warning labels and this manual from the fan.
- NEVER run the fan without all safety guards in place.



## Fan Trouble Shooting

If you are questioning the performance of your fan, check the table below before calling for service.

To use this table, match your problem with the symptom in the left column.

For each symptom, the most likely causes are shown in the middle column and the suggested solutions are shown in the right column:

Symptom	Cause	Solution
Capacity or pressure below rating	Total system resistance is higher than design	Increase fan speed - Contact factory before proceeding
"	Speed too low	Check drive system
"	Dampers or V.I.V.'s not properly adjusted	Reset to correct position
"	Poor fan inlet or outlet conditions	Increase speed; provide turning vanes or baffles in duct work
"	Air leaks in system	Repair duct work
"	Damaged wheel	Repair, followed by balancing. Contact factory before proceeding
"	Rotation direction incorrect	Reverse electrically
Vibration and Noise	Misalignment of drive belts, sheaves, or coupling	Refer to applicable sections to correct
"	Unstable foundation	Refer to applicable sections to correct
"	Foreign material in fan causing unbalance	Clean per manual section
"	Worn bearings	Replace per applicable sections to correct
"	Damaged wheel or motor	Replace wheel or repair and balance wheel
"	Broken or loose bolts	Tighten or replace
"	Bent shaft	Replace with new shaft
"	Worn coupling	Replace with new coupling
"	Fan wheel or drive unbalanced	Balance in place per applicable section



Fan Trouble Shooting  
(continued)

Symptom	Cause	Solution
"	120 Cycle magnetic hum due to electrical input	Check input line for high or unbalanced voltage
Vibration and Noise "	Fan delivering more than rated capacity	Reduce speed, close dampers
"	Loose dampers or V.I.V.'s	Tighten or replace
"	Speed too high or fan rotating in wrong direction	Reduce speed, check electrical connections, reinstall fan wheel
"	Vibration transmitted to fan from other source	Poor installation -refer to applicable manual section
Overheated Bearings	Too much grease in bearings	Clean and re-grease per applicable section
"	Poor alignment	Re-align
"	Bent Shaft	Replace with new piece
"	Dirt in bearings	Clean and re-grease per applicable section
"	Excessive belt tension	Realign and tension per applicable section
Driver Overloaded	Speed too high	Recheck driver selection
"	Volume flow rate over capacity because system resistance is lower than design	Fan improperly specified
"	Rotating wrong direction	Correct per applicable section
"	Wheel wedging or binding	Reinstall wheel
"	Motor wired wrong	Rewire per applicable section



## Motor Trouble Shooting

<b>Symptom</b>	<b>Cause</b>	<b>Solution</b>
Vibration and Noise	Armature unbalanced	Replace with new armature
Vibration and Noise	Loose hold down bolts	Tighten
Motor Laboring	Low or High Voltage	Check supply voltage
High Temperature	Overload	Clean dirt from windings
Armature rubs against stator	Worn Bearings	Replace Bearings
Low Insulation Resistance	Moisture	Check resistance with megohm meter



## Maintenance Procedures

### Rotor Balancing

All Fan Equipment Co., Inc. rotors (wheels) are balanced at the factory before shipment. Most fans shipped assembled have also had a running test performed to confirm mechanical and balance characteristics are correct. A fan handling clean, dry air should not need balancing once it is installed and running properly. Dust or particulate build up on fan rotors causes unbalance. Inspect your fan periodically to determine the amount of blade wear. Blow off any dust or particulate build up on blades and inside the housing before balancing a rotor, check the preceding troubleshooting section.

Portable instruments are available that indicate vibration displacement in mils (1 mil=0.001 inches), or velocity in inches/second. If you have vibration instrumentation, use the table below to determine when your fan is operating with too much vibration.

### Vibration at Fan Operating Frequency

RPM	Initial Operation		Shut Down	
	Mils.	Vel.	Mils.	Vel.
3600	0.53	0.1	2.4	0.45
1800	1.06	0.1	4.77	0.45
1200	1.59	0.1	7.16	0.45
900	2.12	0.1	9.45	0.45
720	2.66	0.1	11.97	0.45
600	3.18	0.1	14.31	0.45

1. When the fan operating frequency falls between the above listed frequencies, the value for the higher frequency should be used.
2. Displacement is a measured value with the probe or seismic type pickup positioned firmly on the fan bearing housing, in the desired plane of measurement. Displacement is a peak-to peak (full wave) value.
3. Initial operation values are expected values for clean, well maintained and balanced fans operating at steady state conditions after transient conditions of start-up, i.e. acceleration, temperature changes, etc. have stabilized. The values (for measurement of equipment unbalance) must be taken for the exact fan operating frequency, filtering out extraneous values that can be measured for different frequencies





4. Operation of any fan above the shut-down levels listed above may cause equipment failure and extensive damage, as well as endangerment to personnel. A corrective measure would be to retain an authorized service representative to inspect the installation, suggest appropriate actions, and balance the rotating assembly as necessary.
5. Fan Equipment Co., Inc. balances and run tests the equipment on a heavy concrete foundation. Installation variables, such as (but not limited to) foundations and mounting provisions, may result in vibration levels somewhat different from the levels achieved at the factory.
6. When vibration isolation systems, such as spring isolators are used, fan balancing should be performed with the isolator components "locked out" to establish a rigid structure. The isolation components should be readjusted after final balance is achieved.

## Bearing Servicing, Cleaning, and Lubrication

### When ball or roller bearings are disassembled for service:

1. Remove bearing races from shaft, place in a suitable container with clean petroleum solvent or kerosene and soak. If kerosene is used, all parts must be wiped dry with a clean cloth. Rotate each bearing by hand to dislodge any dirt particles.
2. Remove old grease and oil from the bearing pillow block. The solvent or kerosene can be used to clean the housing. Carefully wipe all parts dry with a clean cloth to prevent dilution of the new lubricant by the solvent.
3. When bearing grease is badly oxidized, soak in light oil (SAE 10 motor oil) at 200° to 240° F before cleaning as discussed above. Spin the clean bearing in light oil to remove solvent.
4. Reassemble and add lubricant to the correct level.
5. To clean bearings without removing them from the pillow blocks, flush 180° to 200° F light oil, kerosene or solvent through the pillow block while rotating the shaft slowly. Remove badly oxidized grease by flushing with hot aqueous emulsions. Drain the solution, flush the pillow block with hot, light oil and re-drain before adding new lubricant.



---

## Lubrication

This section provides guidelines for the oil and grease lubrication of ball, roller, and sleeve bearings. Most Fan Equipment Co., Inc. fans are furnished with grease lubricated anti-friction bearings. Lubrication schedules are attached to the fan alongside the fan name plate for grease lubricated units. Fans furnished for special service conditions requiring specific lubrication instructions are furnished with this data as part of the fan data submittals. Please contact Fan Equipment Co., Inc. if you require assistance or additional information about the lubrication requirements of your fan.

Fans that are shipped assembled have been lubricated at the factory; but should be checked before start-up. ***Oil lubricated bearings must always be checked as oil can easily spill during shipment.***

Replacement bearings normally are not lubricated. Before installation and lubrication, clean the bearing thoroughly, wash out the rust preventative with a petroleum solvent, and dry the parts with a clean cloth.

Oil lubricated anti-friction bearings are often furnished with TRICO constant level oilers. These assemblies provide a large glass oil reservoir that, after proper adjustment, maintains the correct oil level in the bearing housing. Refer to the instructions later in this section that apply to TRICO oilers.

### Grease Lubricated Bearings

Because bearings operate at high temperatures, a good grade of lubricant is essential. The lube data furnished with your fan unit should be followed. The following table shows acceptable lubricants.

#### **NOTES:**

- ***Not all greases are chemically compatible!*** If you intend to change the grade or type of lubricant; flush out all the old lubricant before proceeding.
- **It is not recommend to use of EP or long-fibered greases.**



Bearings: Split Pillow Block, Double Row, Roller Bearings:

Mfr.	Bearing Type	Grease	Base
Dodge	P2B-500-USAF's	Mobilith SCH100	Lithium
Link-Belt	6800 Series	Mobilith SCH100	Lithium
SKF	SAF-22500's	LGMT 2	Lithium

Bearings: Split Pillow Block, Single Row, Roller Bearings:

Mfr.	Bearing Type	Grease	Base
Dodge	P2B-S2 Series	Exxon Unirex N2	Lithium
Link-Belt	P-B22400 Series	Exxon Ronex MP	Lithium

Bearings: Pillow Block, Single Row, Ball Bearings:

Mfr.	Bearing Type	Grease	Base
Dodge	P2B-SCM Series	Exxon Unirex N2	Lithium
Dodge	P2B-SCH Series	Exxon Unirex N2	Lithium
Sealmaster	MP Series	Goldplex HP	Lithium
Sealmaster	EMP Series	Goldplex HP	Lithium
Dodge	P2B-DLM Series	Exxon Unirex N2	Lithium
Dodge	P2B-DLH Series	Exxon Unirex N2	Lithium
Sealmaster	MP Series	Goldplex HP	Lithium
Sealmaster	EMP Series	Goldplex HP	Lithium
Dodge	P2B-GTM Series	Exxon Unirex N2	Lithium
Dodge	P2B-GTH Series	Exxon Unirex N2	Lithium

Bearings: Flange, Single Row, Ball Bearings:

Mfr.	Bearing Type	Grease	Base
Link-Belt	F-U300 Series	Exxon Ronex MP	Lithium
Link-Belt	FE-U300 Series	Exxon Ronex MP	Lithium
Sealmaster	MSF Series	Goldplex HP	Lithium



## Greasing Procedure

Open the pipe plug or grease relief fitting in the bottom of the pillow block to allow excess grease to escape. Be careful to prevent dirt from entering the bearing. Fill the pillow block approximately 1/3 full. Too much grease can cause the bearing to overheat resulting in premature failure.

## Lubrication Frequency

The lubrication schedule for any application is determined by the operating conditions. Bearings handling clean, dry air at room temperatures will require less frequent lubrication (every 6 to 10 months) than bearings in dirty, hot environments (every 1 to 4 weeks). Re-lubrication is important as it purges contaminants from the bearing. Determine the correct lubrication schedule for your installation by visually examining the purged lubricant. If the lubricant is clean, lengthen the time between re-lubrications; if it is contaminated, shorten the interval.

## Oil Lubricated Bearings

Oil lubricated bearings are much more sensitive to lubrication requirements than grease lubricated units. Lubricating oils must be free from water, sediment acids or resins and have sufficient viscosity for the fan operating temperatures. Viscosity is measured in SUS units (Saybolt Universal Seconds). The larger the SUS rating, the better the filming action of the oil. Viscosity drops as the temperature of the oil increases. A typical SAE 20 weight oil has an SUS rating of 348 at 100° F; and an SUS rating of 57 at 210° F.

Generally oils are provided as follows:

- Ball Bearings.....70 SUS
- Roller Bearings.....100 SUS
- Spherical Thrust Bearings.....150 SUS

Oil	Typical Viscosities
SAE 10 Weight	SUS 183 @ 100° F / 46 @ 210° F
SAE 20 Weight	SUS 348 @ 100° F / 57 @ 210° F
SAE 30 Weight	SUS 489 @ 100° F / 65 @ 210° F



### Oil Lubricating Procedure

With the fan stopped, add oil until the level is 1/4" below the cap of the oil cup attached to the bearing pillow block; or until the oil is at the level mark indicated on the sight gauge (if supplied). If the fan cannot be stopped to check the oil level, an operating oil level must be established. At initial start-up, with the oil at proper level, and the fan at operating temperature; mark the operating oil level while the fan is running. The **minimum** safe operating oil level is 1/8" below this mark.

### Motor Bearing Lubrication

Motors are generally shipped with the bearings lubricated. For specific instructions, consult the motor manufacturer's maintenance manual.



---

## Ordering Replacement Parts

Replacement parts can be ordered from your local sales representative or by contacting Fan Equipment Co., Inc. factory.

***To order replacement parts, the following information is required:***

1. The fan order number or serial number that is stamped on the fan nameplate.
2. The fan size and type.
3. The fan arrangement.
4. Description of part(s).
5. Any special materials of construction, paints, or coatings.

***Additional Information:***

When ordering wheels, shafts, motors, bearings, or drive components, the following additional information is required:

1. Wheel - Indicate type and class of wheel; direction of rotation; operating speed and temperature; material of construction; whether the hub is internal or external to the back plate; the bore and keyway dimensions.
2. Shaft - Provide length; diameter; material; and keyway dimensions.
3. Bearings - For anti-friction bearings, specify: ball or roller type; size; manufacturer; whether fixed or expansion.
4. Drive components - Identify sheave size and type; bushing size; V-belt number and size; or flexible coupling component required.
5. Motors - The name of the motor manufacturer and the nameplate data.

## Recommended Spare Parts

The following spare parts are recommended for all fans:

1. Bearings - Shaft seals and housing split gaskets if furnished for your equipment; oil rings and held bearing liners for sleeve bearings.
2. Drive components - Drive V-belts.
3. Gaskets - Shaft seal(s) and gaskets for housing splits.



For fans operating in hostile environments, where corrosion or erosion is present, ***or for fans that are essential to the operation of your particular system or plant facility***, we recommend the following spare parts inventory:

1. Motor.
2. Fan shaft.
3. Fan wheel.
4. Fan bearings.
5. Drive V-belts.



## Warranty

Unless otherwise agreed upon in writing, all shipments are made F.O.B. shipping point. Responsibility for damage or loss of products is transferred to the owner at this time. Unless specific instructions are included in the customer's purchase order, all shipments will be prepared for common carrier truck transportation. Packaging will be suitable to protect the product under normal circumstances, and to the acceptance standards of the carrier.

Fan Equipment Co., Inc. warrants that the design, construction and materials of our products will be first-class, and free from defects in the materials and workmanship for a period not to exceed eighteen (18) months from shipment or twelve (12) months from date of installation, whichever occurs first. Our sole obligation under this Warranty is limited to the repair or replacement, without charge, at the purchase order F.O.B. point, any defective parts. Fan Equipment Co., Inc. will not be responsible for damages, contingent liabilities, or consequential damages of any nature, resulting from the above stated Warranty; or from any defect in our products, either in materials, design, or construction, or arising from the use of such products. We do not guarantee against abrasion, corrosion, erosion, or accumulation of material on the fan (rotor buildup).

**The above stated Warranty is given expressly in lieu of all other warranties expressed or implied, including warranties of merchantability and fitness for particular purpose, and constitutes the only Warranty made by seller.**





Warranties on equipment not of our manufacture are limited to the Warranty terms of our suppliers.

All Warranty claims must be submitted to Fan Equipment Co., Inc. within ten (10) days of discovery of defect within the warranty period, or shall be deemed waived. Do not attempt to make any repairs on the fan equipment during the warranty period without the prior written authorization of Fan Equipment Co., Inc. or its' representatives; otherwise the Warranty is voided.

Fan Equipment Co., Inc. shall not be liable for any injury to persons or property resulting from improper installation, operation, misapplication, neglect, modification, repair, or maintenance (including lubrication) of equipment by customers or third parties.

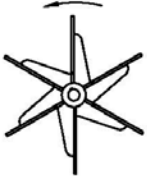
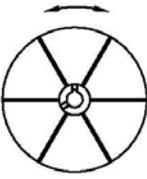
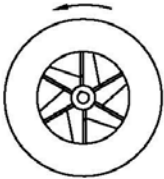
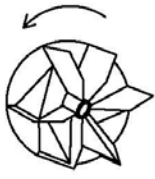

### Wheel Types

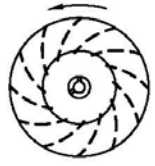
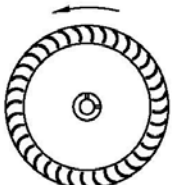
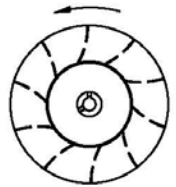
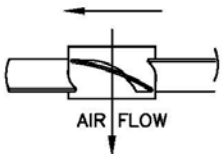
WHEEL TYPES (INLET SIDE VIEW)				
IE:	 <p>'O' TYPE</p>	 <p>'L' TYPE</p>	 <p>'M' TYPE</p>	 <p>'RD' TYPE</p>
HPS: HPO:	 <p>HIGH PRESSURE</p>		AF:	 <p>AIRFOIL</p>
BC:	 <p>BACKWARD INCLINED</p>		BISC: BISC-Q:	 <p>BACKWARD INCLINED SINGLE CAMBER</p>
FC:	 <p>FORWARD CURVED</p>		RT:	 <p>RADIAL TIPPED</p>
VA:	<p>(TOP VIEW OF WHEEL)</p>  <p>AIR FLOW AXIAL FLOW</p>			



---

User's Notes